



Type:

SPECIFICATION SHEET

Project:

Page 1 / 7

DELLA-Decorative DM060



DESCRIPTION

The DELLA Decorative Downlight seamlessly blends aesthetic detail with high-performance lighting. Its custom-color outer ring integrates flush with the ceiling, providing a clean, architectural finish while the 45° cut-off optic ensures visual comfort and low UGR. Ideal for spaces where design and light quality matter—from hotels and restaurants to premium residences—this trimless downlight elevates ceilings with light that feels built in, not added on.

FEATURES

- Flush Architectural Finish - Trimless decorative ring creates a seamless, built-in look.
- Outer ring can be finished to blend with any ceiling color or material.
- 45° cut-off angle reduces glare and maintains low UGR.

SPECIFICATIONS

ELECTRICAL

Power:	10W, 15W
Voltage:	AC 220-240V
Frequency:	50/60Hz
Power Factor:	>0.90
Dimming:	0/1-10V / TRIAC / DALI

OPTICAL

LED Type:	COB
Lumen Output:	781lm (10W), 1042lm (15W)
Beam Optic:	Narrow Spot (15°) / Spot (24°, 33°) / Flood (45°)
Color Quality:	CRI 90+, SDCM ≤ 3
Color Temperature:	Static White: 2700K, 3000K, 3500K, 4000K Tunable White: 2700K-6000K Dim-to Warm: 1800K-3000K

LUMINAIRE

Trim Color:	White / Black / Custom Finish*(Consult Factory)
Operating Temperature:	-20°C~35°C
Lifespan:	>50000h@80% (L80)
Warranty:	5 years Carefree for Parts and Components (Labor not included) LED luminaire life reduction and warranty invalidation will occur if installed in environments above 35°C

DETAILS

Modular Design

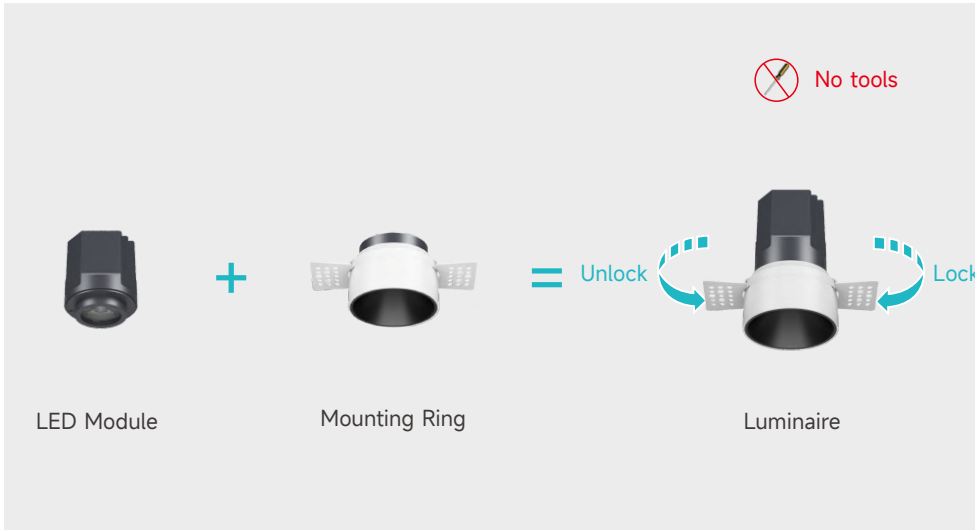

Pull Ring Design (Foldable)

No more hard work, pull out led engine in second.





Type:

Project:

ORDERING INFORMATION

DM060							
MODULE	TRIM	LUMEN	TRIM COLOR	CRI	CCT	OPTIC	DIMMING
<input type="checkbox"/> DM060 DELLA 75mm Aperture (IP20) <input type="checkbox"/> DM060P DELLA 75mm Aperture (IP65)	<input type="checkbox"/> DF61RF02T Decorative	<input type="checkbox"/> L07 700lm <input type="checkbox"/> L10 1000lm	<input type="checkbox"/> W White <input type="checkbox"/> B Black <input type="checkbox"/> C Custom Finish *(Consult Factory)	<input type="checkbox"/> 9 90+	<input type="checkbox"/> 27 2700K <input type="checkbox"/> 30 3000K <input type="checkbox"/> 35 3500K <input type="checkbox"/> 40 4000K <input type="checkbox"/> TW Tunable White 2700K-6000K <input type="checkbox"/> DW Dim-to Warm 1800K-3000K	<input type="checkbox"/> 015 Narrow Spot 15° <input type="checkbox"/> 024 Spot 24° <input type="checkbox"/> 033 Spot 33° <input type="checkbox"/> 045 Flood 45°	<input type="checkbox"/> V 0/1-10V <input type="checkbox"/> T Triac <input type="checkbox"/> D DALI

ACCESSORIES (TO BE ORDERED SEPARATELY)
FOR INSTALLATION CONSULT THE INSTRUCTION SHEET

OPTICAL ACCESSORY

Honeycomb
DM60-H



Soft Lens
DM60-L





Type:

Project:

PHOTOMETRIC DATA (NON-DIMMING)

LUMEN PACKAGE	POWER	CCT	15°			24°			33°			45°		
			LUMENS	EFFICACY	MAX CANDELA	LUMENS	EFFICACY	MAX CANDELA	LUMENS	EFFICACY	MAX CANDELA	LUMENS	EFFICACY	MAX CANDELA
DM060-DF61RF02T	10W	3000K	621	60	5653	727	70	4553	758	73	2526	781	75	1436
DM060-DF61RF02T	15W	3000K	822	56	7476	970	66	6062	1024	69	3421	1042	70	1911

Above test data is based on [Decorative \(DF61RF02T\)](#) trim with 3000K 90CRI LED.

LUMEN MULTIPLIERS

CCT	MULTIPLIER
2700K	0.95
3000K	1.00
3500K	1.04
4000K	1.06

Applying Lumen Multipliers to Calculate Delivered Lumens

Base Fixture Delivered Lumens (from PHOTOMETRIC DATA)	x	CCT Multiplier	=	Delivered Lumens for Desired Fixture
STANDARD TRIM Example: DM060-DF61RF02T 10W 3500K				
621 lm	x	1.04	=	646 lm

LIGHT DISTRIBUTION

3000K 10W

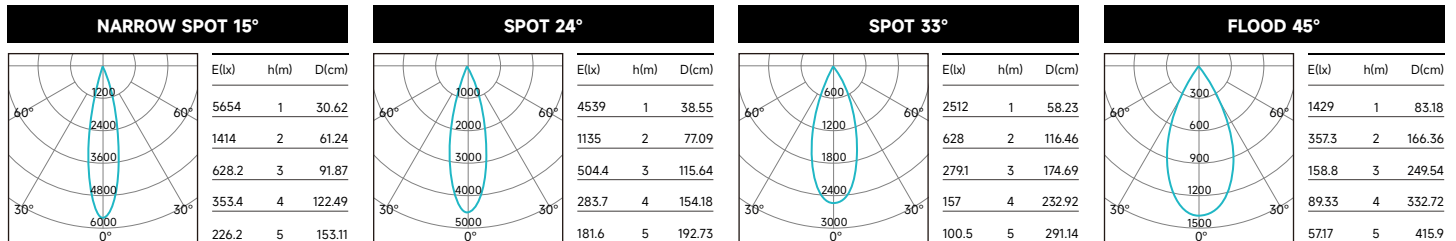

3000K 15W

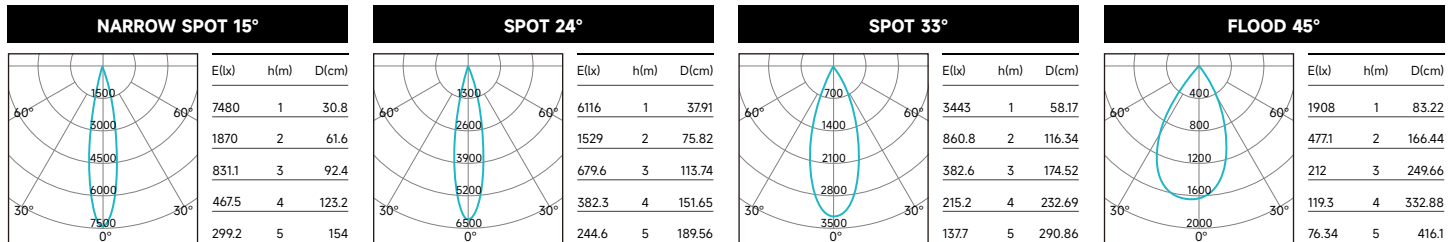

Above test data is based on [Decorative \(DF61RF02T\)](#) with 3000K 90CRI LED.

EXPLODED OVERVIEW - PART SELECTION

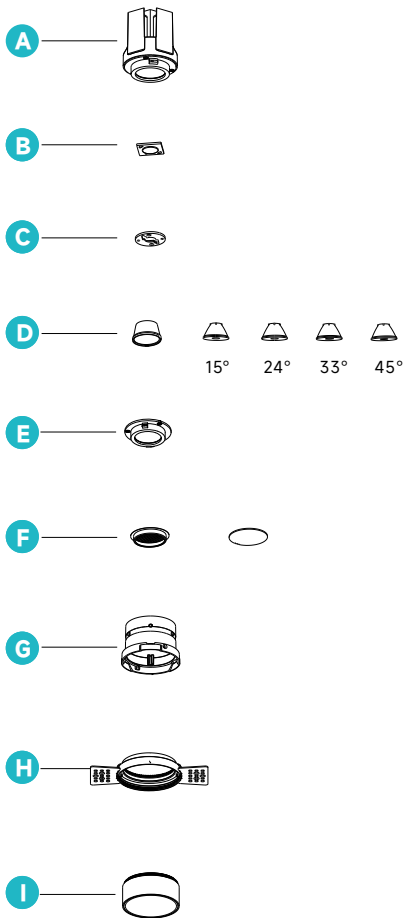
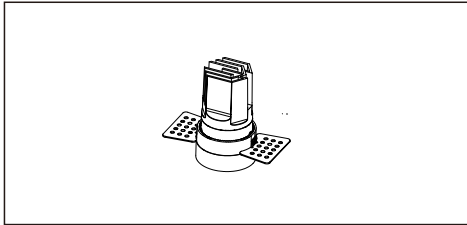

PARTS

- A** - Led Module
- B** - Light Source
 - Static White: 2700K, 3000K, 3500K, 4000K
 - Tunable White: 2700K-6000K
 - Dim-to Warm: 1800K-3000K
- C** - LED Holder
- D** - Beam Lens (15° / 24° / 33° / 45°)
- E** - Fixed Ring
- F** - Honeycomb, Soft Lens
- G** - Precise Angle Alignment (Round-Fixed)
- H** - Decorative Trim For One Light Engine
- I** - Decorative Ring



Type:

Project:

BEAM CUT OFF ANGLE

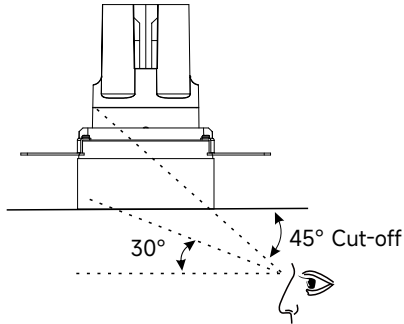

DIMENSION

LED Module



DM060 / DM060P

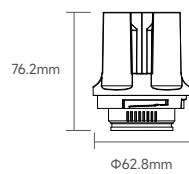

Trim For Hotel Series



Decorative

DM060-DF61RF02T / DM060P-DF61RF02T

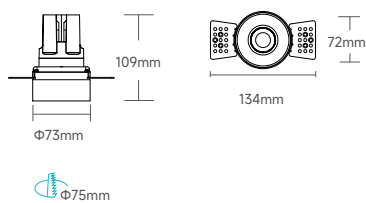



Type:

Project:



DELLA 2.0 DOWNLIGHT SYSTEM

DELLA, a system of downlights stands out with its exceptional light control technology and anti-glare performance. The system offers multiple sizes ranging from Ø35mm to Ø75mm, with power ratings from 5W to 20W. flexibly adapting to diverse scenarios. Its super modular design enables all optical accessories to be replaced without tools, ensuring smooth operation and a robust structure. Compact, high-efficiency, and evolution-ready design makes DELLA a reliable choice for high-end retail, hospitality, and residential lighting.

DELLA 2.0 is not merely a recessed lighting system; it is our profound interpretation of the relationship between light and space.

DETAILS



Scan to know more about product information