



Type:

**SPECIFICATION SHEET**

Project:

Page 1 / 7

# DELLA-IP65

## DM060/DM060P



### DESCRIPTION

DELLA Downlight is available in both IP20 and IP65 versions. Its sleek concave trim and narrow frame design seamlessly integrate into architectural ceilings. Crafted for luxurious settings—such as five-star hotel corridors, villa bathrooms, and semi-outdoor terraces—it delivers exceptional optical performance in spaces where aesthetics and ambiance are paramount.

### FEATURES

- True IP65-rated for the entire fixture, suitable for humid environments such as bathrooms and semi-outdoor corridors.
- Smooth concave trim with minimal bezel for a discreet, built-in appearance.
- Deep 30° Cut-Off Optic ensures glare-free visual comfort, ideal for refined residential and hospitality settings.

### SPECIFICATIONS

#### ELECTRICAL

Power:	10W, 15W
Voltage:	AC 220-240V
Frequency:	50/60Hz
Power Factor:	>0.90
Dimming:	0/1-10V / TRIAC / DALI

#### OPTICAL

LED Type:	COB
Lumen Output:	750lm (10W), 999lm (15W)
Beam Optic:	Narrow Spot (15°) / Spot (24°, 33°) / Flood (45°)
Color Quality:	CRI 90+, SDCM≤3
Color Temperature:	Static White: 2700K, 3000K, 3500K, 4000K Tunable White: 2700K-6000K Dim-to Warm: 1800K-3000K

#### LUMINAIRE

Trim Color:	White / Black / Custom Finish*(Consult Factory)
Operating Temperature:	-20°C~35°C
Lifespan:	>50000h@80% (L80)
Warranty:	5 years Carefree for Parts and Components (Labor not included) LED luminaire life reduction and warranty invalidation will occur if installed in environments above 35°C

#### PHYSICAL

Ceiling Thickness:	1mm to 20mm spring clip
Construction:	Aluminum
Mounting:	Recessed with spring clips

**DETAILS**

**Modular Design**



**IP65 rated for wet location**





Type:

Project:

**ORDERING INFORMATION**

DM060P							
MODULE	TRIM	LUMEN	TRIM COLOR	CRI	CCT	OPTIC	DIMMING
<input type="checkbox"/> <b>DM060</b> DELLA 75mm Aperture (IP20)	<input type="checkbox"/> <b>DF62RF02N</b> IP65	<input type="checkbox"/> <b>L07</b> 700lm	<input type="checkbox"/> <b>W</b> White	<input type="checkbox"/> <b>9</b> 90+	<input type="checkbox"/> <b>27</b> 2700K	<input type="checkbox"/> <b>015</b> Narrow Spot 15°	<input type="checkbox"/> <b>V</b> 0/1-10V
<input type="checkbox"/> <b>DM060P</b> DELLA 75mm Aperture (IP65)		<input type="checkbox"/> <b>L09</b> 900lm	<input type="checkbox"/> <b>B</b> Black		<input type="checkbox"/> <b>30</b> 3000K	<input type="checkbox"/> <b>024</b> Spot 24°	<input type="checkbox"/> <b>T</b> Triac
			<input type="checkbox"/> <b>C</b> Custom Finish *(Consult Factory)		<input type="checkbox"/> <b>35</b> 3500K	<input type="checkbox"/> <b>033</b> Spot 33°	<input type="checkbox"/> <b>D</b> DALI
					<input type="checkbox"/> <b>40</b> 4000K	<input type="checkbox"/> <b>045</b> Flood 45°	
					<input type="checkbox"/> <b>TW</b> Tunable White 2700K-6000K		
					<input type="checkbox"/> <b>DW</b> Dim-to Warm 1800K-3000K		

**ACCESSORIES** (TO BE ORDERED SEPARATELY)  
FOR INSTALLATION CONSULT THE INSTRUCTION SHEET

**OPTICAL ACCESSORY**

**Honeycomb**  
DM60P-H



**Soft Lens**  
DM60P-L





Type:

Project:

**PHOTOMETRIC DATA (NON-DIMMING)**

LUMEN PACKAGE	POWER	CCT	15°			24°			33°			45°		
			LUMENS	EFFICACY	MAX CANDELA	LUMENS	EFFICACY	MAX CANDELA	LUMENS	EFFICACY	MAX CANDELA	LUMENS	EFFICACY	MAX CANDELA
DM060P-DF62RF02N	10W	3000K	630	61	4983	704	68	3986	717	69	2081	750	72	1166
DM060P-DF62RF02N	15W	3000K	822	56	6625	954	64	5388	963	65	2794	999	67	1550

Above test data is based on IP65 (DF62RF02N) trim with 3000K 90CRI LED.

**LUMEN MULTIPLIERS**

CCT	MULTIPLIER
2700K	0.95
3000K	1.00
3500K	1.04
4000K	1.06

**Applying Lumen Multipliers to Calculate Delivered Lumens**

Base Fixture Delivered Lumens (from PHOTOMETRIC DATA)	x	CCT Multiplier	=	Delivered Lumens for Desired Fixture
<b>STANDARD TRIM Example: DM060P-DF62RF02N 10W 3500K</b>				
630 lm	x	1.04	=	655 lm

**LIGHT DISTRIBUTION**

**3000K 10W**

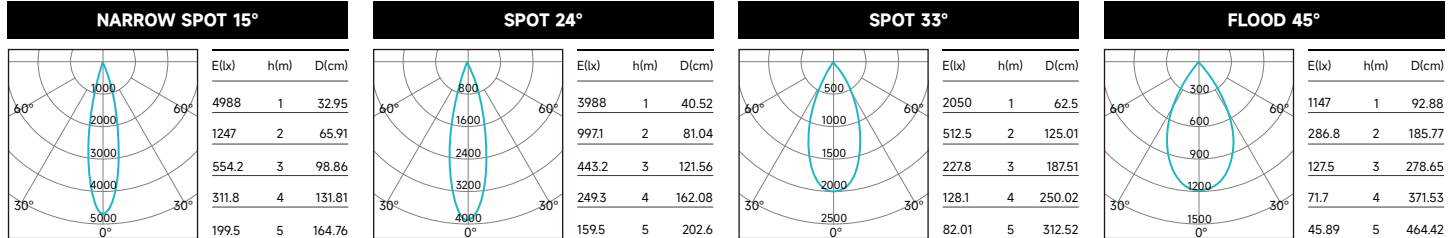

**3000K 15W**

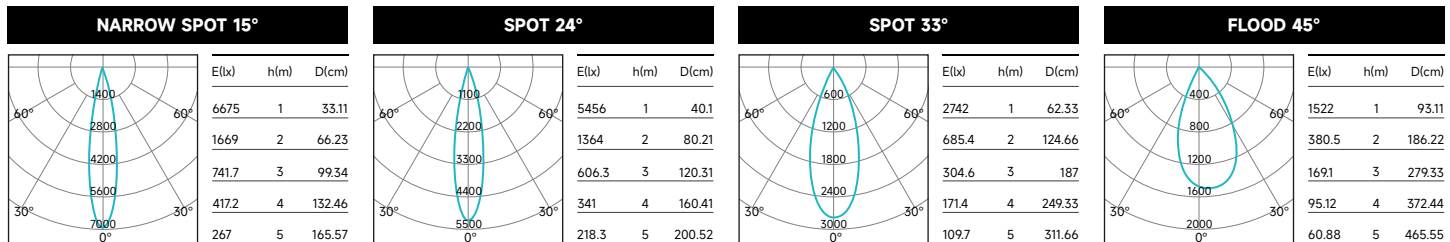

Above test data is based on IP65 (DF62RF02N) with 3000K 90CRI LED.

**EXPLODED OVERVIEW - PART SELECTION**

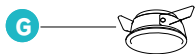
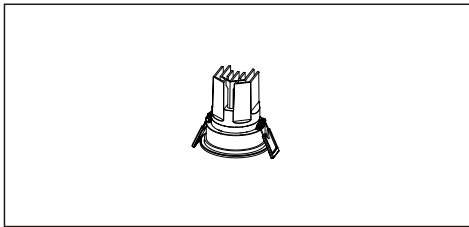

**PARTS**

- A** - Led Module
- B** - Light Source
  - Static White: 2700K, 3000K, 3500K, 4000K
  - Tunable White: 2700K-6000K
  - Dim-to Warm: 1800K-3000K
- C** - LED Holder
- D** - Beam Lens (15° / 24° / 33° / 45°)
- E** - Fixed Ring
- F** - Honeycomb, Soft Lens
- G** - IP65 Trim For One Light Engine



Type:

Project:

**BEAM CUT OFF ANGLE**

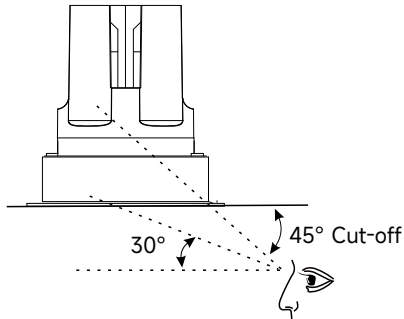

**DIMENSION**

**LED Module**



DM060 / DM060P

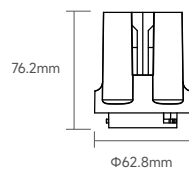

**Trim For Hotel Series**



IP65

DM060-DF62RF02N / DM060P-DF62RF02N

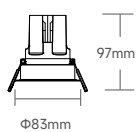



Type:

Project:



### DELLA 2.0 DOWNLIGHT SYSTEM

DELLA, a system of downlights stands out with its exceptional light control technology and anti-glare performance. The system offers multiple sizes ranging from Ø35mm to Ø75mm, with power ratings from 5W to 20W. flexibly adapting to diverse scenarios. Its super modular design enables all optical accessories to be replaced without tools, ensuring smooth operation and a robust structure. Compact, high-efficiency, and evolution-ready design makes DELLA a reliable choice for high-end retail, hospitality, and residential lighting.

DELLA 2.0 is not merely a recessed lighting system; it is our profound interpretation of the relationship between light and space.

### DETAILS



Scan to know more about product information