



Type:

Project:

ELLA-Hotel

EM060



DESCRIPTION

ELLA-Hotel series is not only an aesthetic designed downlight, but also release high quality light thanks to combination of a precision light beam lens and secondary reflector. The luminaires blend elegantly into the ceiling layout and embody the philosophy of "light instead of luminaires." Super modular design, round as well as square with adjustable and fixed options, in various wattages, ELLA-hotel series is a great choice to get a unified impression in one environment.

FEATURES

- Elegant & compact in its style, versatile in its using.
- Precise light control, 15°, 24°, 38°, 50° beam lens options.
- Interchangeable different color secondary reflectors for anti-glare and decorative function.
- Super modular design, replacing LED module, trims, beam lens, honeycomb filter and secondary reflectors without any needs for tools.
- 355° rotation and 30° tilt.
- Anti-glare accessories provide maximum visual comfort.
- Service the LED optics and Driver from above the ceiling.

SPECIFICATIONS

ELECTRICAL

Power:	10W, 15W
Voltage:	220-240V / 100-277V AC
Frequency:	50/60Hz
Power Factor:	>0.90
Dimming :	0/1-10V / TRIAC / DALI / CASAMBI

OPTICAL

LED Type:	COB
Lumen Output:	893lm (10W), 1158lm (15W)
Beam Optic:	Narrow Spot (15°) / Spot (24°, 38°) / Flood (50°)
Color Quality:	CRI 80+/90+, SDCM≤3
Color Temperature:	Static White: 2700K, 3000K, 3500K, 4000K Tunable White: 2700K-6000K Dim-to Warm: 2000K-3000K

LUMINAIRE

Trim Color:	White / Black / Custom Finish*(Consult Factory)
Operating Temperature:	-10°C~30°C
Lifespan:	>50000h@80% (L80)
Warranty:	5 years Carefree for Parts and Components (Labor not included) LED luminaire life reduction and warranty invalidation will occur if installed in environments above 30°C

PHYSICAL

Adjustment Range:	Adjustable (0°-355°rotation, 0°-30°tilt)
Ceiling Thickness:	1mm to 20mm spring clip
Construction:	Aluminum
Mounting:	Recessed with spring clips

DETAILS



ORDERING INFORMATION

EM060							
MODULE	TRIM	LUMEN	TRIM COLOR	CRI	CCT	OPTIC	DIMMING
<input type="checkbox"/> EM060 ELLA 75mm Aperture	<input type="checkbox"/> EF61RA01 Round Adjustable	<input type="checkbox"/> L08 800lm	<input type="checkbox"/> W White	<input type="checkbox"/> 8 80+	<input type="checkbox"/> 27 2700K	<input type="checkbox"/> 015 Narrow Spot 15°	<input type="checkbox"/> V 0/1-10V
	<input type="checkbox"/> EF61RF01 Round Fixed	<input type="checkbox"/> L11 1100lm	<input type="checkbox"/> B Black	<input type="checkbox"/> 9 90+	<input type="checkbox"/> 30 3000K	<input type="checkbox"/> 024 Spot 24°	<input type="checkbox"/> T Triac
	<input type="checkbox"/> EF61SA01 Square Adjustable		<input type="checkbox"/> C Custom Finish *(Consult Factory)		<input type="checkbox"/> 35 3500K	<input type="checkbox"/> 038 Spot 38°	<input type="checkbox"/> X 0-10V/Triac
	<input type="checkbox"/> EF61RA01T Round Adjustable Trimless				<input type="checkbox"/> 40 4000K	<input type="checkbox"/> 050 Flood 50°	<input type="checkbox"/> D DALI
	<input type="checkbox"/> EF61RF01T Round Fixed Trimless				<input type="checkbox"/> TW Tunable White 2700K-6000K		<input type="checkbox"/> C CASAMBI
	<input type="checkbox"/> EF61SA01T Square Adjustable Trimless				<input type="checkbox"/> DW Dim To Warm 2000K-3000K		

ACCESSORIES (TO BE ORDERED SEPARATELY)
 FOR INSTALLATION CONSULT THE INSTRUCTION SHEET

OPTICAL ACCESSORY

- | | |
|---|---|
| <input type="checkbox"/> Honeycomb
EM060-H
 | <input type="checkbox"/> Soft Lens
EM060-L
 |
|---|---|

SECONDARY REFLECTOR COLOR

- | | | | | |
|--|---|---|--|---|
| <input type="checkbox"/> Matt Black
EF61RA-MB
EF61RF-MB
EF61SA-MB
 | <input type="checkbox"/> Bright Silver
EF61RA-BS
EF61RF-BS
EF61SA-BS
 | <input type="checkbox"/> Matt Silver
EF61RA-MS
EF61RF-MS
EF61SA-MS
 | <input type="checkbox"/> Matt White
EF61RA-MW
EF61RF-MW
EF61SA-MW
 | <input type="checkbox"/> Custom Finish
*(Consult Factory) |
|--|---|---|--|---|



Type:

Project:

PHOTOMETRIC DATA (NON-DIMMING)

LUMEN PACKAGE	POWER	CCT	15°			24°			38°			50°		
			LUMENS	EFFICACY	MAX CANDELA	LUMENS	EFFICACY	MAX CANDELA	LUMENS	EFFICACY	MAX CANDELA	LUMENS	EFFICACY	MAX CANDELA
EM060-EF61RA01	10W	3000K	802	76	4936	875	83	3821	893	88	2248	852	84	1258
EM060-EF61RA01	15W	3000K	1059	73	6576	1158	80	5072	1124	82	2980	1123	81	1666

Above test data is based on [Round Adjustable\(EF61RA01\)](#) trim with 3000K 90CRI LED.

LUMEN MULTIPLIERS

CCT	MULTIPLIER
2700K	0.95
3000K	1.00
3500K	1.04
4000K	1.06

Applying Lumen Multipliers to Calculate Delivered Lumens

Base Fixture Delivered Lumens (from PHOTOMETRIC DATA)	x	CCT Multiplier	=	Delivered Lumens for Desired Fixture
STANDARD TRIM Example: EM060-EF61RA01 10W 3500K				
802 lm	x	1.04	=	834 lm

LIGHT DISTRIBUTION

3000K 10W

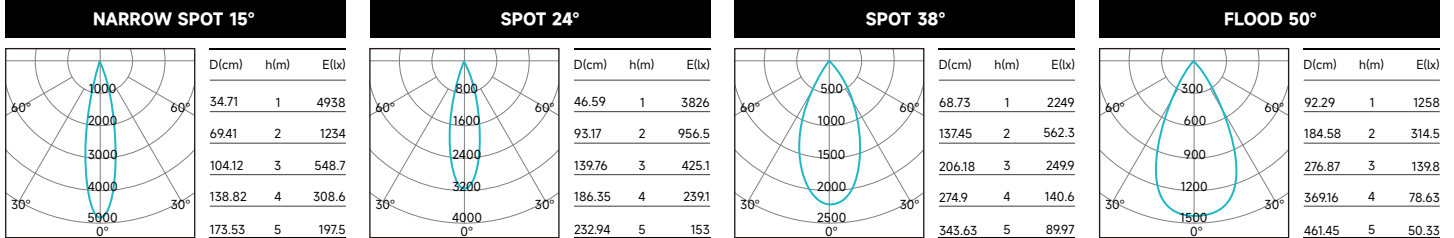

3000K 15W

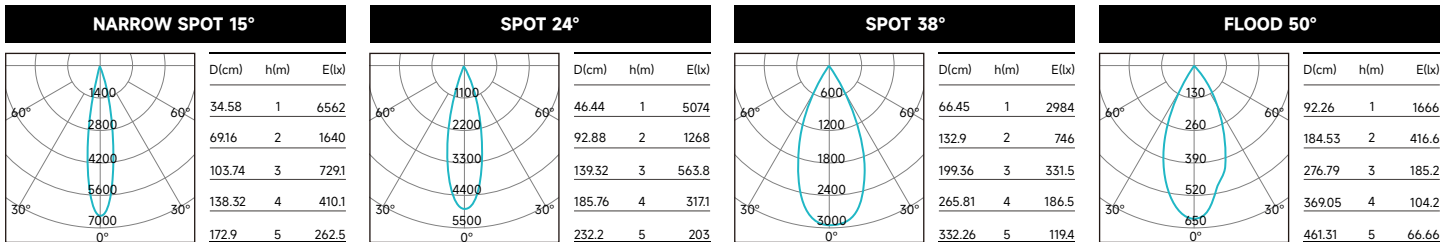

Above test data is based on [Round Adjustable\(EF61RA01\)](#) trim with 3000K 90CRI LED.

EXPLODED OVERVIEW - PART SELECTION

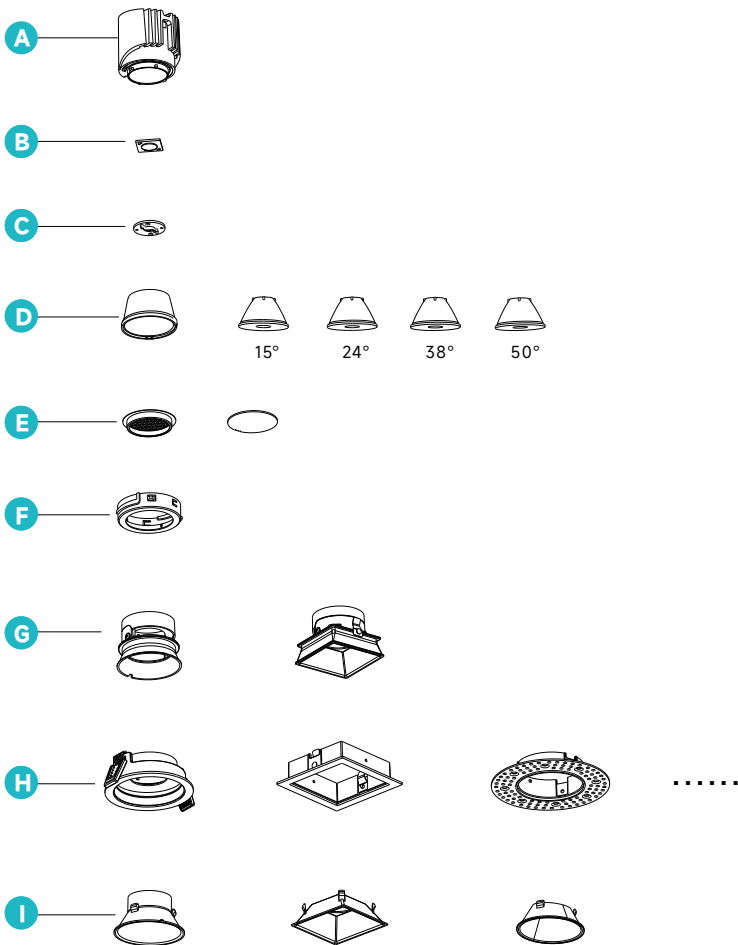
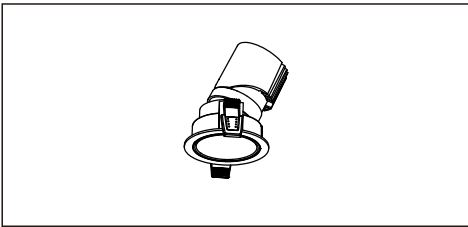

PARTS

- A** - Led Module
- B** - Light Source
 - Static White: 2700K, 3000K, 3500K, 4000K
 - Dim To Warm: 2000K-3000K
 - Tunable White: 2700K-6000K
- C** - LED Holder
- D** - Beam Lens (15° / 24° / 38° / 50°)
- E** - Honeycomb, Soft Lens
- F** - Fixed Ring
- G** - Precise Angle Alignment
 - (Round-Fixed)
 - Precise Angle Alignment
 - (Square-Adjustable)
- H** - Round Adjustable Trim For One Light Engine
 - Round Adjustable Trimless Trim For One Light Engine
 - Round Fixed Trim For One Light Engine
 - Round Fixed Trimless For One Light Engine
 - Square Adjustable Trim For One Light Engine
 - Square Adjustable Trimless For One Light Engine
- I** - Interchangeable Secondary Reflector
 - (Round-Fixed)
 - Interchangeable Secondary Reflector
 - (Square-Adjustable)
 - Interchangeable Secondary Reflector
 - (Round-Adjustable)

BEAM CUT OFF ANGLE

Adjustable (0°Tilt)

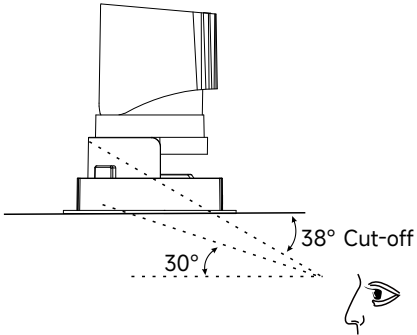

ADJUSTMENT

355° Rotation

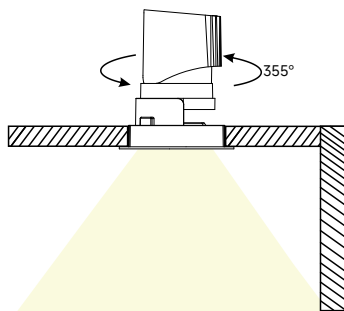

(For round trim only)

0° to 30° Tilt Adjustment

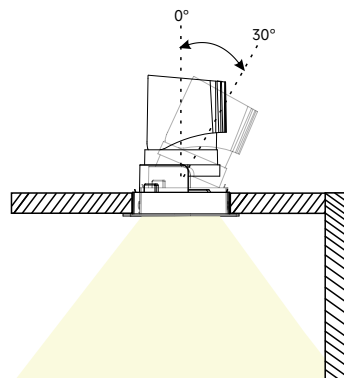

DIMENSION

LED Module



EM060

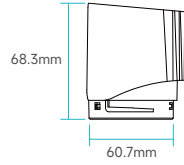

Trim For ELLA-Hotel Series



EM060-EF61RA01

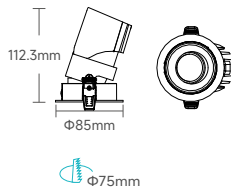

Round Adjustable



EM060-EF61RA01T

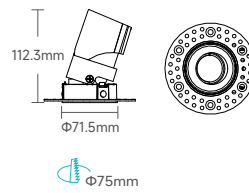

Round Adjustable Trimless



EM060-EF61RF01

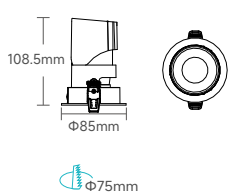

Round Fixed



EM060-EF61RF01T

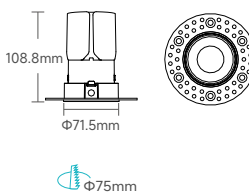

Round Fixed Trimless



EM060-EF61SA01

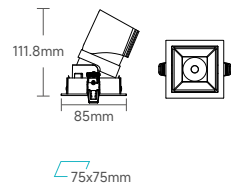

Square Adjustable



EM060-EF61SA01T

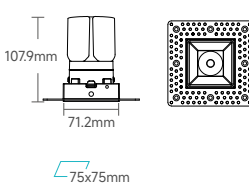

Square Adjustable Trimless



Type:

Project:



ELLA DOWNLIGHT SYSTEM

ELLA is the latest evolution of VILLA downlight system. In addition to aesthetic design, precise light control and great UGR, the versatility of ELLA, underwritten by its compact format and super modular design, one LED Module shares numerous mounting rings, display particular strength in hotels, residential, or any indoor commercial environments. Round as well as square designs with adjustable and fixed options, in various wattages enable nuanced adaptations to different needs.

DETAILS



Scan to know more about product information